

N-Channel Enhancement Mode Field Effect Transistor

PRODUCT SUMMARY		
V _{DSS}	I _D	R _{DS(ON)} (mΩ) Max
100V	10A	213 @ V _{GS} =10V

FEATURES

- Super high dense cell design for low R_{DS(ON)}.
- Rugged and reliable.
- TO-252 and TO-251 Package.

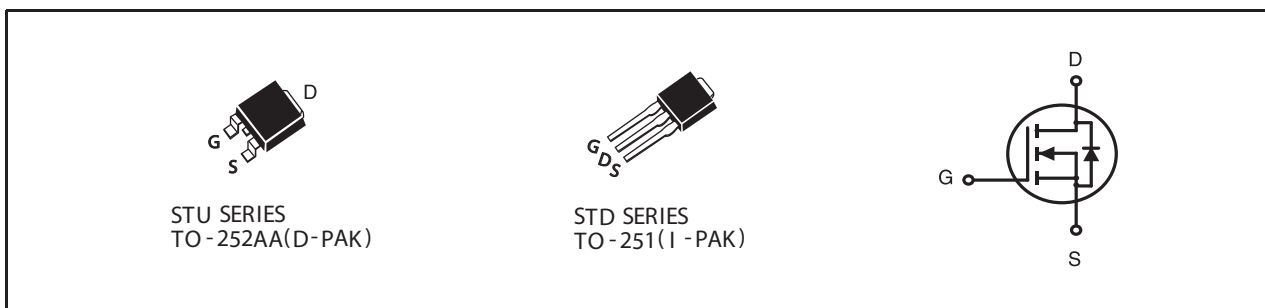

ABSOLUTE MAXIMUM RATINGS (T_A=25°C unless otherwise noted)

Symbol	Parameter	Limit	Units
V _{DS}	Drain-Source Voltage	100	V
V _{GS}	Gate-Source Voltage	±20	V
I _D	Drain Current-Continuous ^a	T _C =25°C	10
		T _C =70°C	8
I _{DM}	-Pulsed ^b	29	A
E _{AS}	Single Pulse Avalanche Energy ^d	11	mJ
P _D	Maximum Power Dissipation ^a	T _C =25°C	50
		T _C =70°C	32
T _J , T _{STG}	Operating Junction and Storage Temperature Range	-55 to 150	°C

THERMAL CHARACTERISTICS

R _{θ JC}	Thermal Resistance, Junction-to-Case ^a	2.5	°C/W
R _{θ JA}	Thermal Resistance, Junction-to-Ambient ^a	50	°C/W

UD0002U

Ver 1.0

ELECTRICAL CHARACTERISTICS (T_A=25°C unless otherwise noted)

Symbol	Parameter	Conditions	Min	Typ	Max	Units
OFF CHARACTERISTICS						
BV _{DSS}	Drain-Source Breakdown Voltage	V _{GS} =0V , I _D =250uA	100			V
I _{DSS}	Zero Gate Voltage Drain Current	V _{DS} =80V , V _{GS} =0V			1	uA
I _{GSS}	Gate-Body Leakage Current	V _{GS} = ±20V , V _{DS} =0V			±100	nA
ON CHARACTERISTICS						
V _{GS(th)}	Gate Threshold Voltage	V _{DS} =V _{GS} , I _D =250uA	1	1.8	3	V
R _{DS(ON)}	Drain-Source On-State Resistance	V _{GS} =10V , I _D =5A		170	213	m ohm
g _{FS}	Forward Transconductance	V _{DS} =20V , I _D =5A		5.5		S
DYNAMIC CHARACTERISTICS ^c						
C _{ISS}	Input Capacitance	V _{DS} =25V, V _{GS} =0V f=1.0MHz		310		pF
C _{OSS}	Output Capacitance			35		pF
C _{RSS}	Reverse Transfer Capacitance			20		pF
SWITCHING CHARACTERISTICS ^c						
t _{D(ON)}	Turn-On Delay Time	V _{DD} =50V I _D =1A V _{GS} =10V R _{GEN} = 6 ohm		8		ns
t _r	Rise Time			9		ns
t _{D(OFF)}	Turn-Off Delay Time			16.5		ns
t _f	Fall Time			3.5		ns
Q _g	Total Gate Charge	V _{DS} =50V, I _D =5A, V _{GS} =10V		5.5		nC
Q _{gs}	Gate-Source Charge	V _{DS} =50V, I _D =5A, V _{GS} =10V		1		nC
Q _{gd}	Gate-Drain Charge			2		nC
DRAIN-SOURCE DIODE CHARACTERISTICS AND MAXIMUM RATINGS						
V _{SD}	Diode Forward Voltage	V _{GS} =0V, I _S =1A		0.785	1.3	V

Notes

- Surface Mounted on FR4 Board, t ≤ 10sec.
- Pulse Test: Pulse Width ≤ 300us, Duty Cycle ≤ 2%.
- Guaranteed by design, not subject to production testing.
- Starting T_J=25°C, L=0.5mH, V_{DD} = 50V. (See Figure13)

Sep,02,2010

UD0002U

Ver 1.0

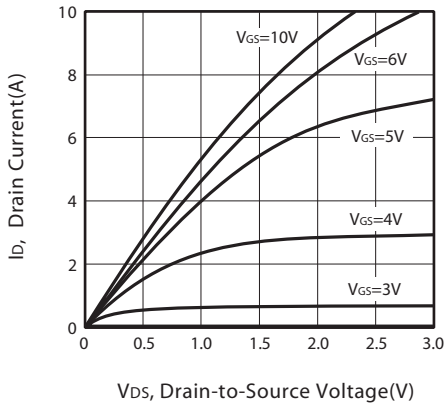

Figure 1. Output Characteristics

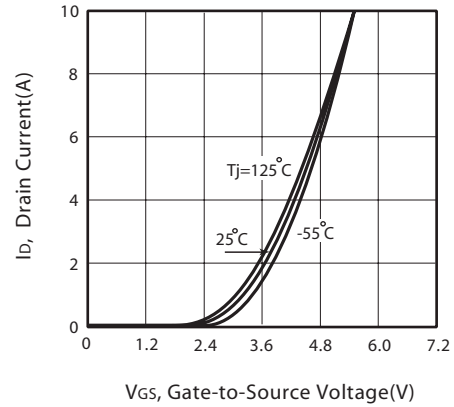

Figure 2. Transfer Characteristics

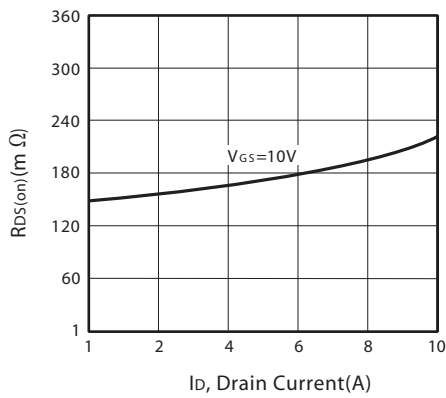

Figure 3. On-Resistance vs. Drain Current and Gate Voltage

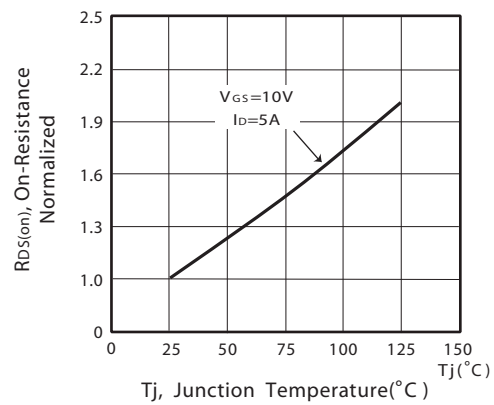

Figure 4. On-Resistance Variation with Drain Current and Temperature

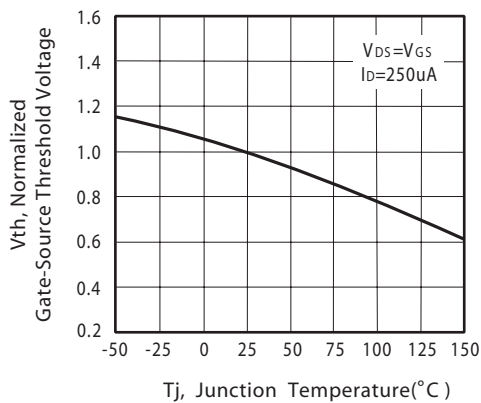

Figure 5. Gate Threshold Variation with Temperature

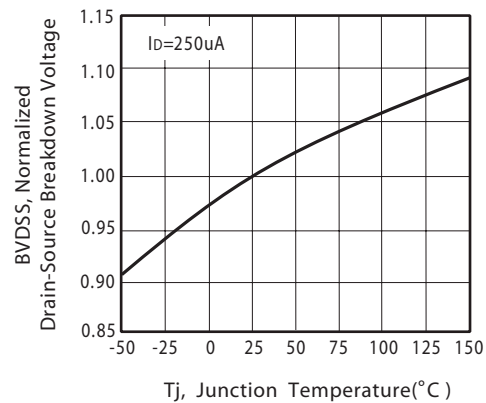

Figure 6. Breakdown Voltage Variation with Temperature

Sep,02,2010

UD0002U

Ver 1.0

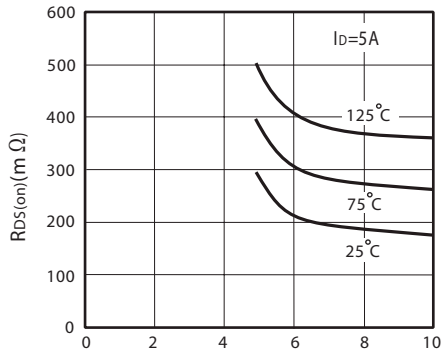

Figure 7. On-Resistance vs. Gate-Source Voltage

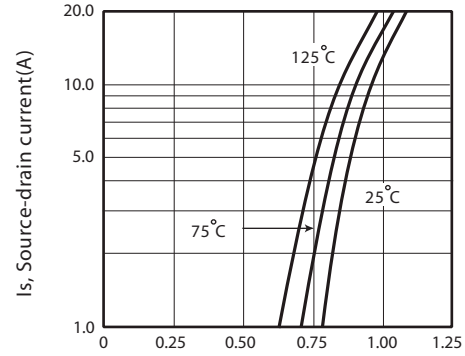

Figure 8. Body Diode Forward Voltage Variation with Source Current

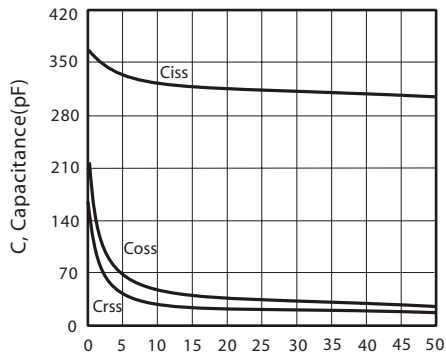

Figure 9. Capacitance

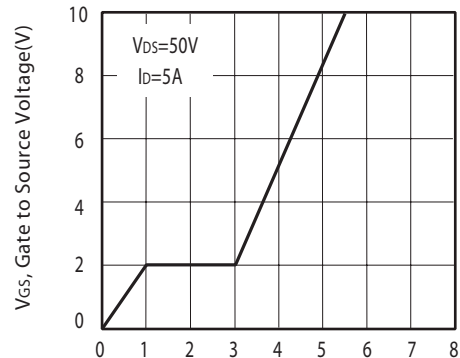

Figure 10. Gate Charge

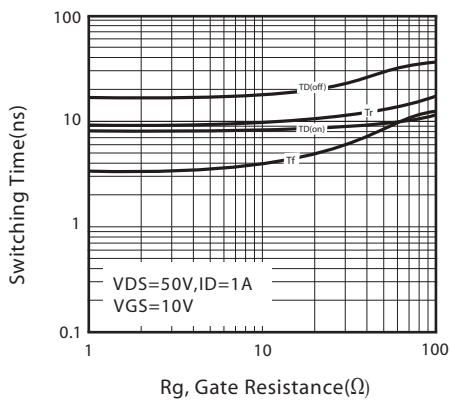

Figure 11. switching characteristics

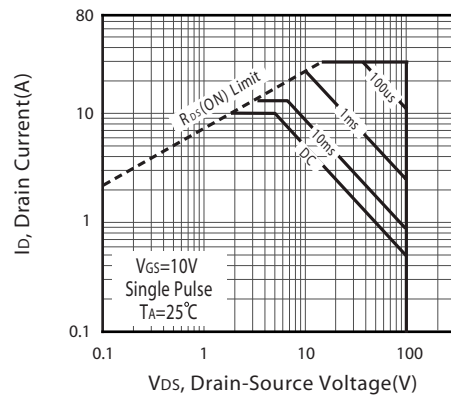
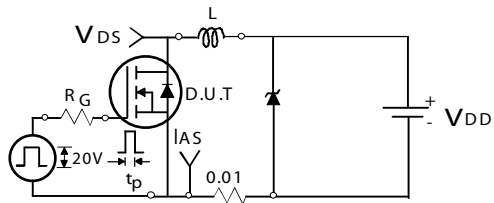

Figure 12. Maximum Safe Operating Area

Sep,02,2010

UD0002U

Ver 1.0



Unclamped Inductive Test Circuit

Figure 13a.

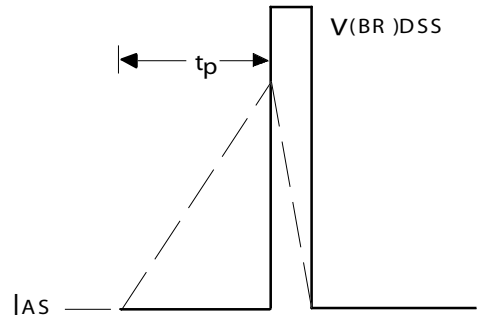

Unclamped Inductive Waveforms

Figure 13b.

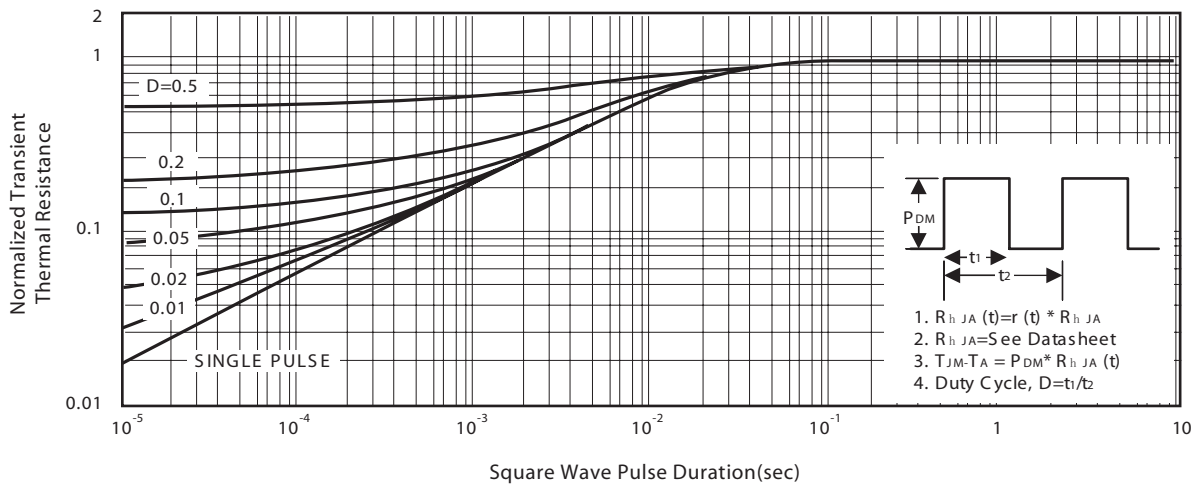

Figure 14. Normalized Thermal Transient Impedance Curve

Sep,02,2010

UD0002U

Ver 1.0

PACKAGE OUTLINE DIMENSIONS

TO-251

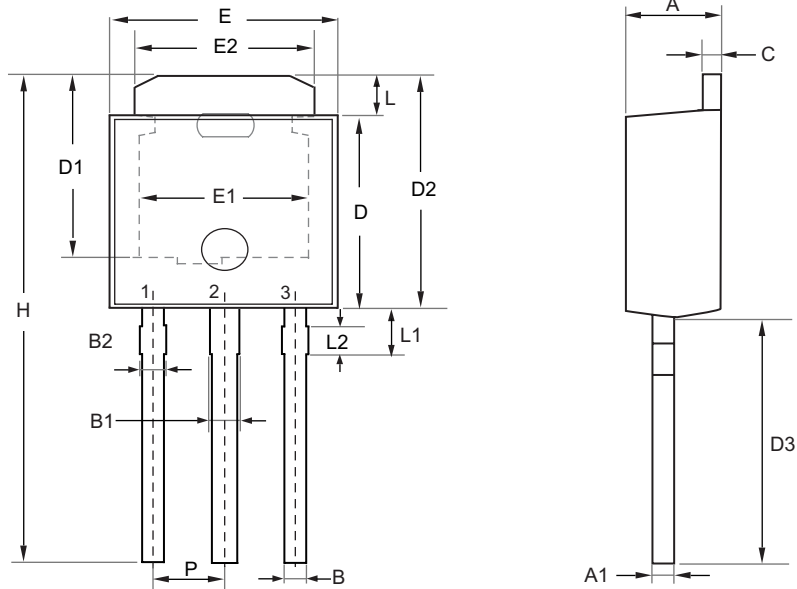

SYMBOL	MILLIMETERS		INCHES	
	MIN	MAX	MIN	MAX
A	2.100	2.500	0.083	0.098
A1	0.350	0.650	0.014	0.026
B	0.400	0.800	0.016	0.031
B1	0.650	1.050	0.026	0.041
B2	0.500	0.900	0.020	0.035
C	0.400	0.600	0.016	0.024
D	5.300	5.700	0.209	0.224
D1	4.900	5.300	0.193	0.209
D2	6.700	7.300	0.264	0.287
D3	7.000	8.000	0.276	0.315
H	13.700	15.300	0.539	0.602
E	6.300	6.700	0.248	0.264
E1	4.600	4.900	0.181	0.193
E2	4.800	5.200	0.189	0.205
L	1.300	1.700	0.051	0.067
L1	1.400	1.800	0.055	0.071
L2	0.500	0.900	0.020	0.035
P	2.300 BSC		0.091 BSC	

Sep,02,2010

UD0002U

Ver 1.0

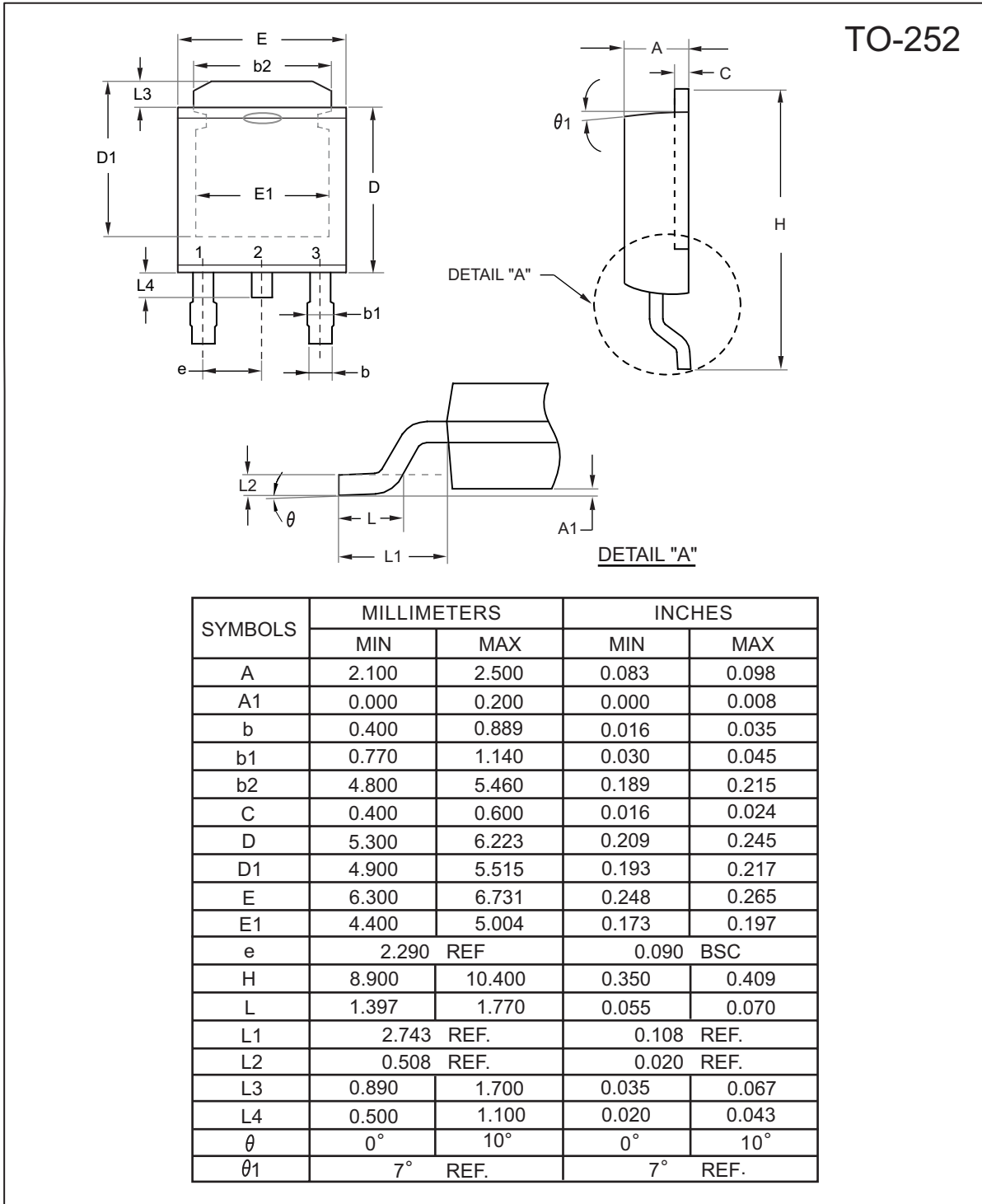

Sep.02,2010

UD0002U

Ver 1.0

TO-251 Tube/TO-252 Tape and Reel Data

TO-251 Tube

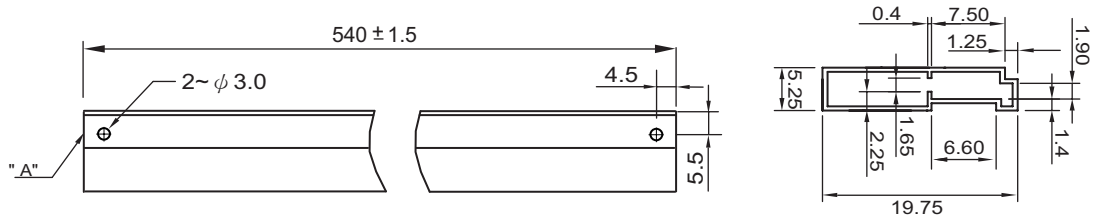

TO-252 Carrier Tape

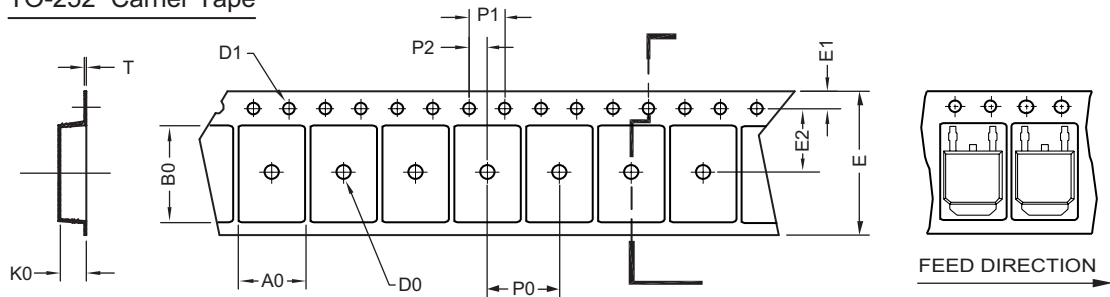

UNIT:mm

PACKAGE	A0	B0	K0	D0	D1	E	E1	E2	P0	P1	P2	T
TO-252 (16 mm)	6.96 ±0.1	10.49 ±0.1	2.79 ±0.1	φ 2	φ 1.5 + 0.1 - 0	16.0 ±0.3	1.75 ±0.1	7.5 ±0.15	8.0 ±0.1	4.0 ±0.1	2.0 ±0.15	0.3 ±0.05

TO-252 Reel

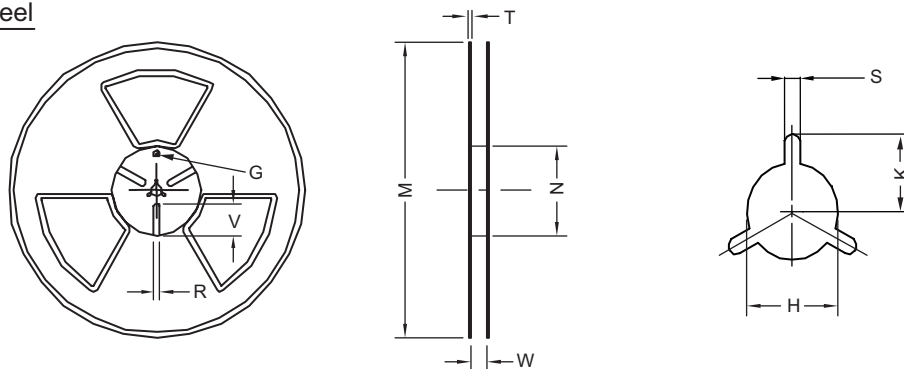

UNIT:mm

TAPE SIZE	REEL SIZE	M	N	W	T	H	K	S	G	R	V
16 mm	φ 330	φ 330 ± 0.5	φ 97 ± 1.0	17.0 + 1.5 - 0	2.2	φ 13.0 + 0.5 - 0.2	10.6	2.0 ±0.5	---	---	---

Sep.02,2010